

LED Exterior Wall Sconce

EW71305

INSTALLATION SHEET

START FROM HERE

- Make sure **POWER** is **COMPLETELY OFF** at the fuse box
- Have your fixture installed by a qualified licensed electrician
- Prepare everything in a clear area
- Wear gloves at all time during this installation
- Read instructions carefully before you start assembly
- Keep this installation sheet for future reference

Technical Support: 1-855-855-8926

Please Note:

- All Kuzco LED fixtures come with pre-wired LED module(s).
- Unless instructed to do so, please do not touch any part of the LED module(s) as any unnecessary contact with the module could cause permanent damage.
- For dimming, an ELV (Electronic Low Voltage) type of dimmer is required.

- 1.** Remove the fixture from its original packaging. Remove the mounting plate (**1c**) from within the canopy (**2b**) by unthreading the four set screws (**2a**). Attach this mounting plate (**1c**) to the electrical junction box (**1a**), using screws (**1d**) provided in the hardware package.
- 2.** Attach the canopy backplate to the mounting plate, which is attached to the electrical junction box on the wall. First connect all wires correctly G ground to ground, N neutral wire (white to white), L live wire (black to black) with provided marettes (**1b**) from the hardware package. Now place the canopy (**2b**) onto the mounting plate (**1c**). As you move the canopy, align the holes to the holes on the mounting plate (**1c**). Secure the canopy by using all four set screws (**2a**) with the allen key provided in the hardware package.

- 3.** To prevent moisture from entering the outlet box and causing a short, seal around the top and side perimeter between the fixture and the wall surface with weather resistant caulking (illustration 1). The space at bottom should be left un-caulked to prevent moisture build-up. Apply a small amount of weather resistant caulking around the side perimeter between the cap nut and mounting plate.
- 4.** You have now completed the installation of your fixture, please enjoy.

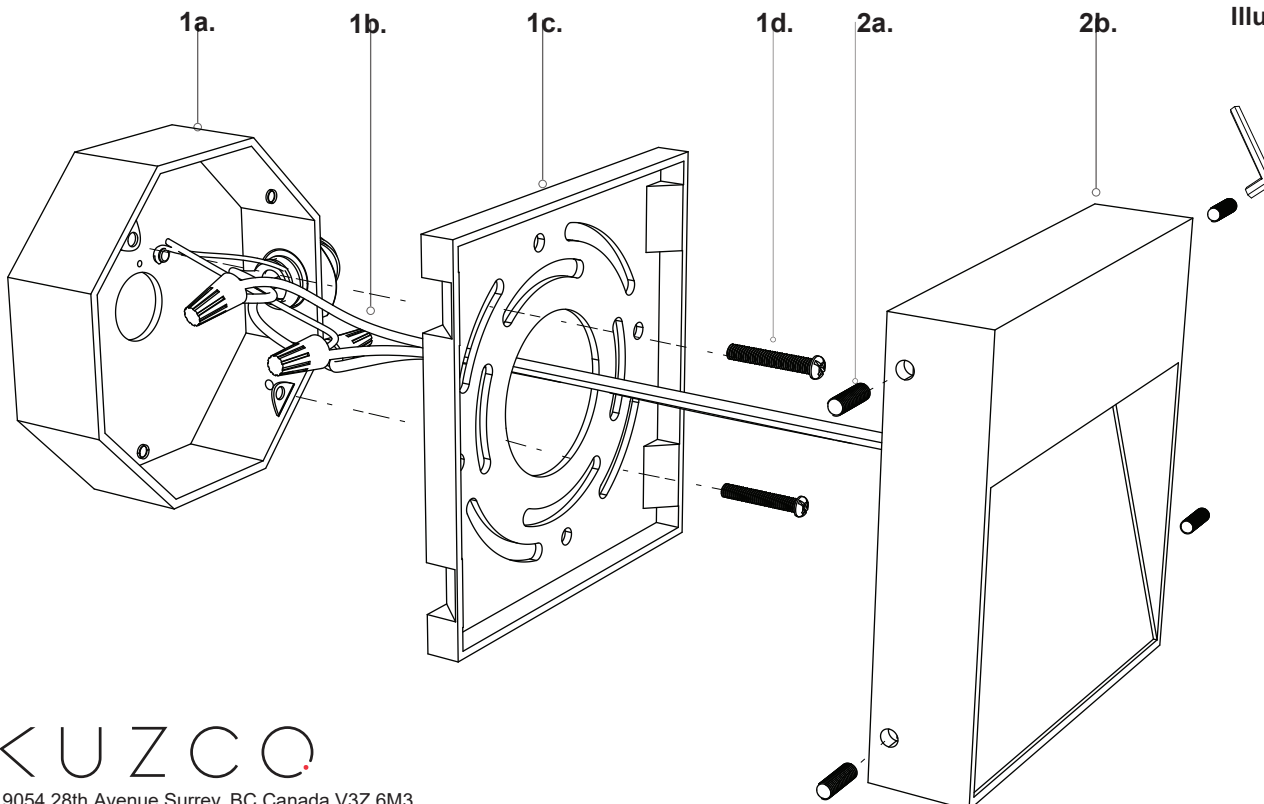

Illustration 1.

KUZCO

19054 28th Avenue Surrey, BC Canada V3Z 6M3
T: 604 538 7162 TF: 1-855 85 KUZCO F: 604 538 7196
W: kuzcolighting.com
20181127